

**PRINCIPAL DIMENSION**

LENGTH OVER ALL	68,000 M
LENGTH PERPENDICULAR	62,000 M
LENGTH WATER LINE	64,000 M
BREADTH MOULDED	13,500 M
DEPTH MOULDED	5,700 M
DRAUGHT	2,750 M

NO.	ALTERATION	DATE
PROJECT	LANDING CRAFT UTILITY 1000 DWT	
CONSTRUCTION PROFILE		
APPROVED	BY THE SUPERVISOR	DATE
DATE	NO. 0202.1-IV	

**PRINCIPAL DIMENSION**

LENGTH OVER ALL : 68,000 M  
 LENGTH PERPENDICULAR : 62,000 M  
 LENGTH WATER LINE : 64,000 M  
 BREADTH MOULDED : 13,500 M  
 DEPTH MOULDED : 5,700 M  
 DRAUGHT : 2,750 M

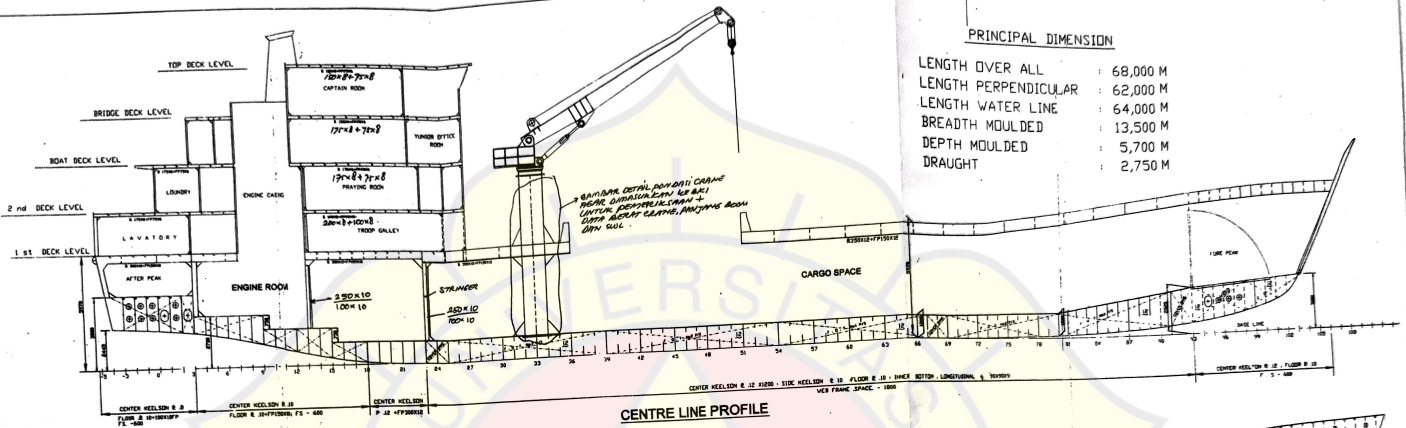

**CENTRE LINE PROFILE**

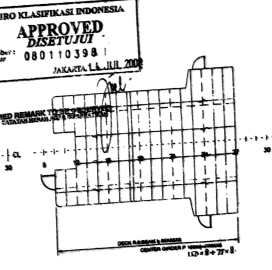
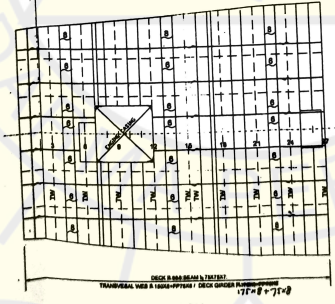
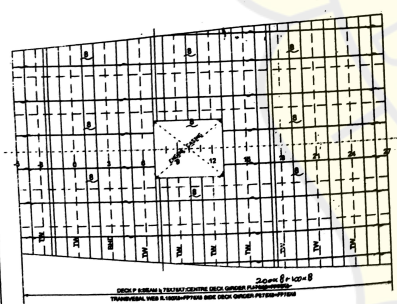
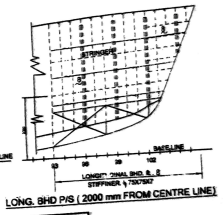
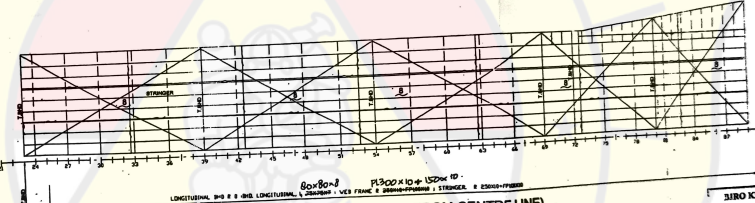
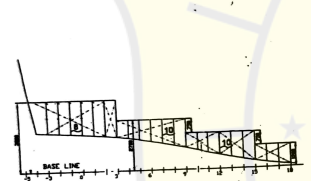

DIREKTORAT PERENCANAAN DAN KONTROL MUTU  
 DEPT. PERENCANAAN DAN KONTROL MUTU  
 JALAN SUDIRMAN NO. 100  
 JAKARTA 15110

SIRO KLASIFIKASI INDONESIA  
**APPROVED**  
**DISERTUJUI**  
 No. Siro: 080110398  
 JALAN SUDIRMAN NO. 100  
 JAKARTA 15110

NO.	REVISI	ALTERNATIF	DATE	APP. NO.
1	1	1000 DWT	10/10/2008	

PROJECT: LANDING CRAFT UTILITY 1000 DWT  
 TITLE: CONSTRUCTION PROFILE  
 DRAWING NO: N-0202

STARBOARD SIDE

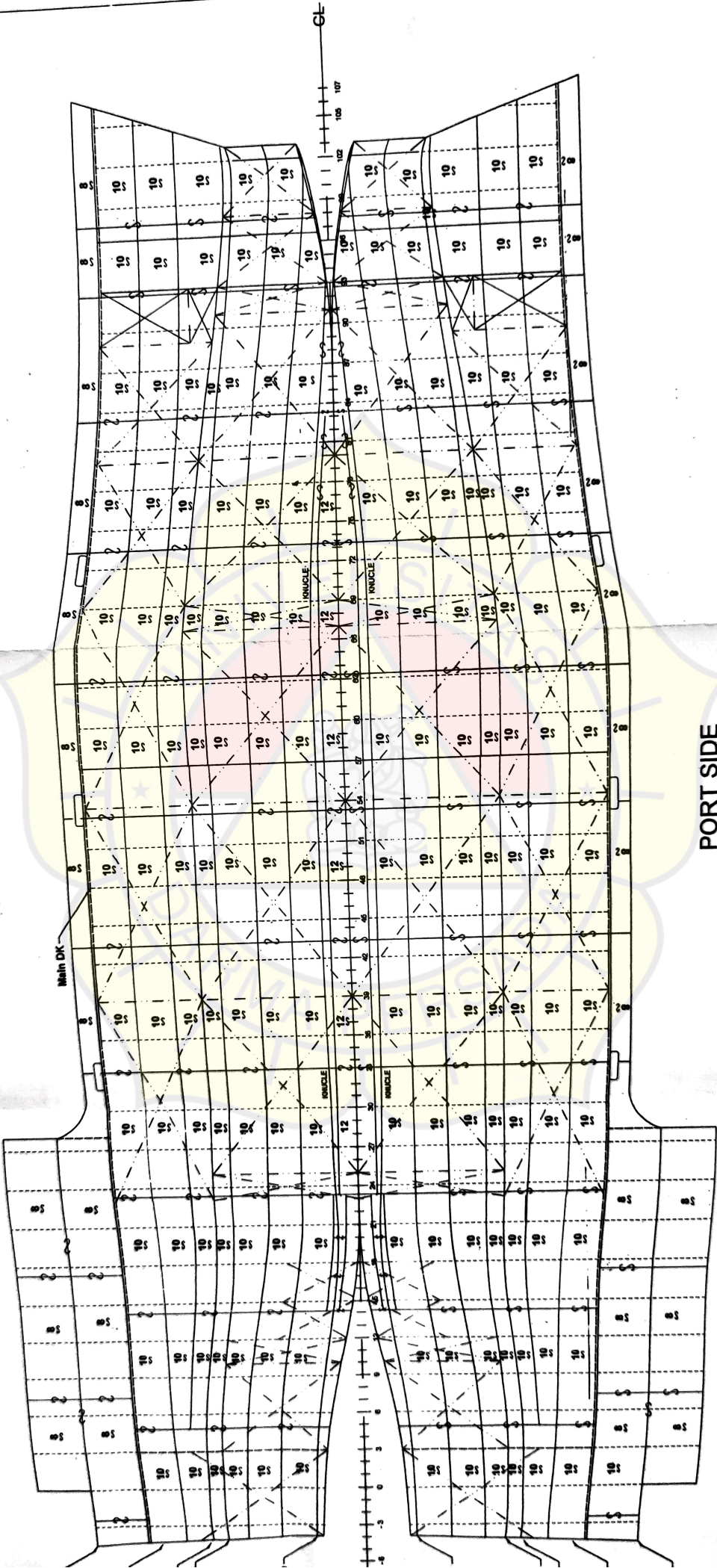

PORT SIDE

PRINCIPAL DIMENSION  
 LENGTH OVER ALL : 68.00 M  
 LENGTH PERPENDICULAR : 64.00 M  
 LENGTH WATER LINE : 13.500 M  
 BREADTH MOLDED : 5.700 M  
 DEPTH MOLDED : 2.750 M  
 DRAUGHT : 4.400 M

DATE		APP'D	SCALE
DATE		APPROVED	1 : 100
DATE		CHECKED	
DATE		DATE	
PROJECT : LANDING CRAFT UTILITY 1000 DWT		SHEET NO.	
TITLE : SHELL EXPANSION		Dwg No. : DKB/190-1311/JKT	
		REVISED BY : H. 0203 - IV	

P. 1 OF 8 REVISIONS (SEE SHEETS)  
 PROJECT : LANDING CRAFT UTILITY 1000 DWT  
 TITLE : SHELL EXPANSION  
 Dwg No. : DKB/190-1311/JKT  
 REVISED BY : H. 0203 - IV

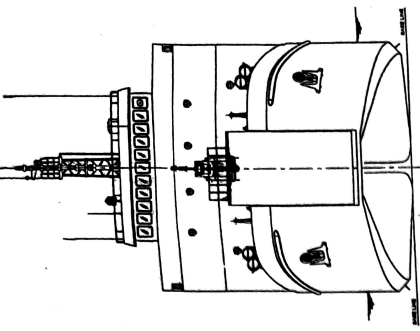

FRONT VIEW

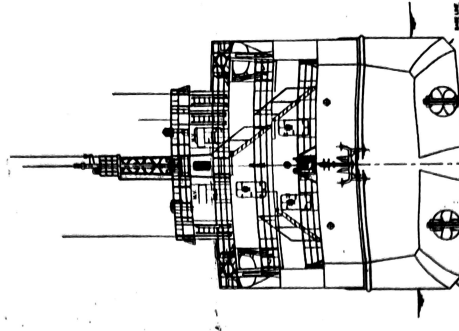

AFTER VIEW  
GALANGAN II  
CONTROLLED COPY  
ENGINEERING  
No. 19-77-9  
P. 10/11-99

PRINCIPAL PARTICULARS OF SHIP  
 LENGTH OVER ALL : 68.000 Meter  
 LENGTH PERPENDICULAR : 64.000 Meter  
 LENGTH WATER LINE : 13.500 Meter  
 BREADTH MOULDED : 5.700 Meter  
 DEPTH MOULDED : 2.750 Meter  
 DRAUGHT :

APPROVED	NO.	ALTERNATION	DATE	APP. '99
PROJECT : LANDING CRAFT UTILITY 1000 DWT			SCALE	APPROVED A.T.
TITLE : GENERAL ARRANGEMENT			1:150	CHECKED SIC.
				DRAWN
				DATE
				13-11-99
			SHEET	
			NO. 10	
			PT. DOK & PERALAPAN KODIA BAHARI	
			( PERSERO )	
			DKB/1310-1311/JKT	
			FORMED NO.	
			G-0301	

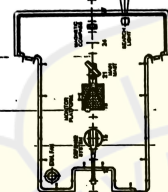

TOP DECK

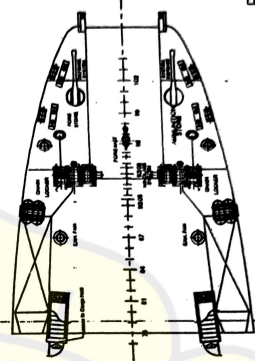

F.C. DECK

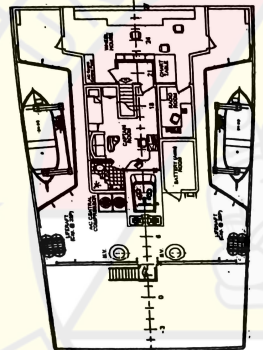
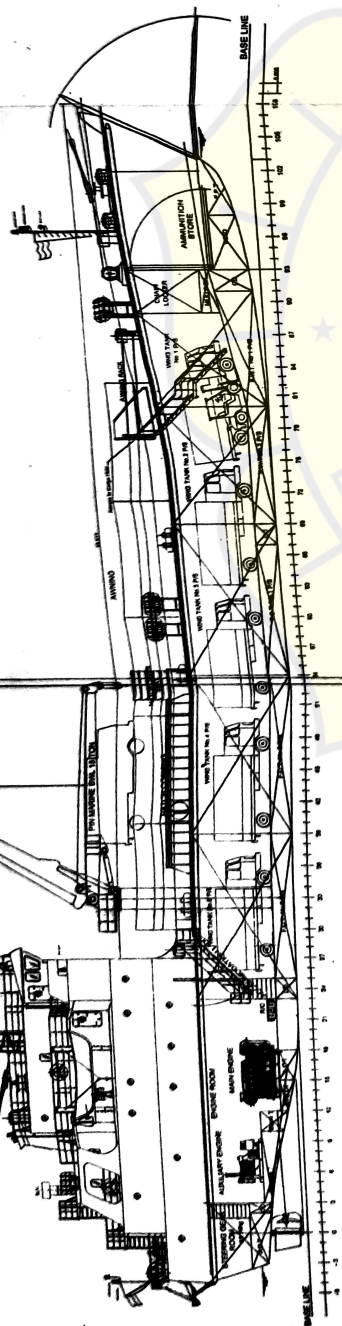

BRIDGE DECK

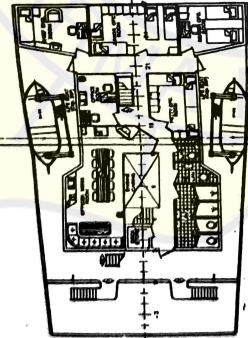

BOAT DECK

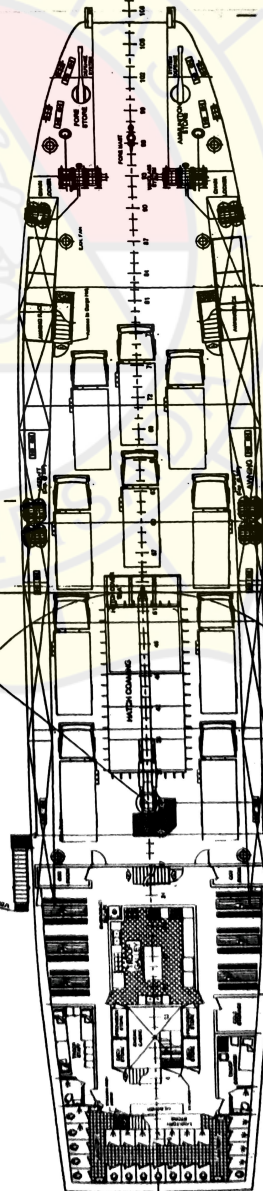

MAIN DECK

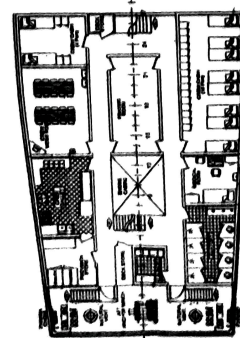

POOP DECK

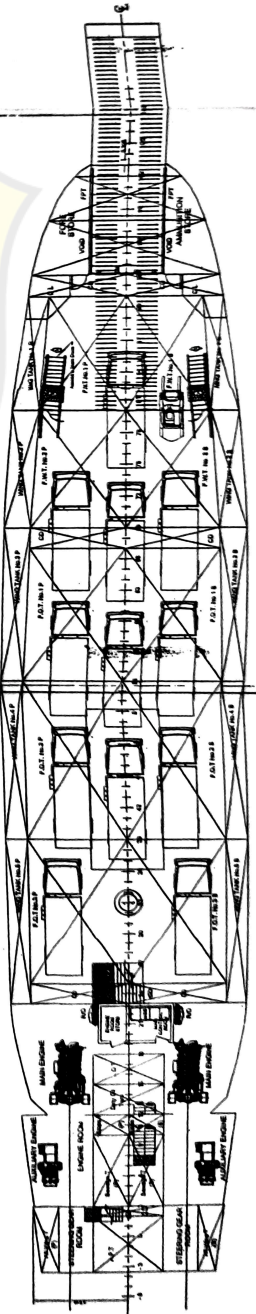

TANK TOP

BASE LINE  
DECK LEVEL  
EX LEVEL  
EX LEVEL  
EX LEVEL  
BASE LINE



PT. DOK & PERALAPAN KODIA BAHARI  
( PERSERO )  
Jl. Raya Garuda No. 100  
Jakarta Barat, Indonesia  
Telp. (021) 6631111, 6631112, 6631113  
Faks. (021) 6631114

DKB  
PT. DOK & PERALAPAN KODIA BAHARI  
PT. DOK & PERALAPAN KODIA BAHARI



DOUBLE BOTTOM

MAIN DECK

**PRINCIPAL DIMENSION**  
 LENGTH O.A. : 68.00M  
 LENGTH P.P. : 62.00M  
 BREADTH : 13.50M  
 DEPTH : 5.70M

  
 GALANGAN III  
 CONSTRUCTION  
 COPY NO.

NO.		ALTERATION	
PROJECT		LANDING CRAFT UTILITY 1000 DWT	
TITLE		BLOCK DIVISION	
SCALE		DATE	
APPROVED		APR. 78	
CHECKED		DATE	
DRAWN		DATE	
DATE		DATE	

ALL

P. S. BOK & PERKAWALAN KUALA BAHAR  
 (PENGENG) Sdn Bhd  
 GALANGAN IV  
 No. 17, Jalan...  
 10000...  
 (100) CANTON...

VARD NO. 1610  
 NO DKB 1611  
 JKT.



Service & Operation